

robosen
THE ROBOT COMPANY



TRANSFORMERS and HASBRO and all related trademarks and logos are trademarks of Hasbro, Inc. ©2024 Hasbro.



© TOMY 「トランスフォーマー」、「TRANSFORMERS」は株式会社タカラトミーの登録商標です。

THE TRANSFORMERS
MORE THAN MEETS THE EYE!



QUICK START GUIDE

1. What's In the Box / 包装清单 / 包裝清單 / 梱包リスト / 포장 내용물 /
Contenu de la boîte / Lieferumfang / Componentes de la Caja /
Cosa c'è nella scatola / Wat Zit er In de Doos

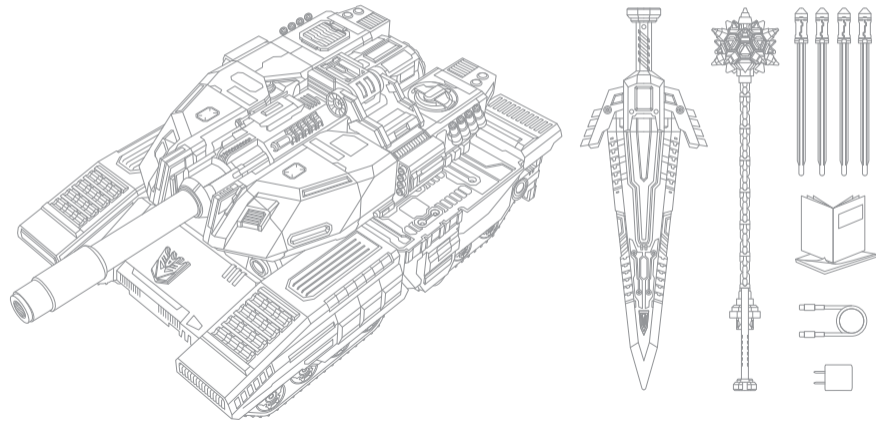

2. Power ON/OFF / 开关机 / 開關機 / 電源オン/オフ / 전원 켜기/끄기 /
 Mise sous/hors tension / Einschalter/Ausschalter / Encendido/
 Apagado de Fuente de Alimentación / Accensione/Spegnimento /
 Stroom AANZETTEN / UITZETTEN



5s

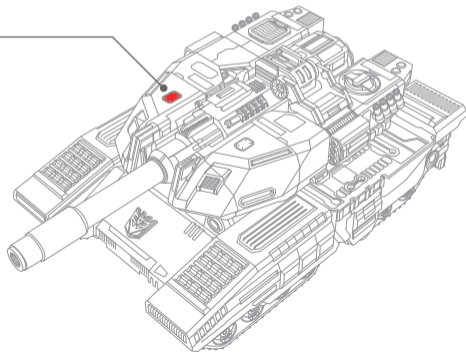

EN Long press for 5s
 CHS 长按5秒
 CHT 长按5秒
 JP 5秒間長押し
 KR 5초 동안 길게 누르기
 FR Appui long pour 5 secondes
 DE Für 5 Sekunden gedrückt halten
 ES Mantenga presionado por 5 s
 IT Premi a lungo per 5s
 NL Lang drukken voor 5s

3. Wake Up & Convert / 喚醒&變形 / 喚醒&變形 / 웨이크업&변
 형 / 깨우기 및 변신 / Réveiller et convertir / Aufwecken und Trans-
 formieren / Despertar y Transformar / Sveglia e conversione /
 Word Wakker en Converteer



Say "Hey, Megatron!"
 说“嘿，威震天！”



"Convert!"
 “变形！”

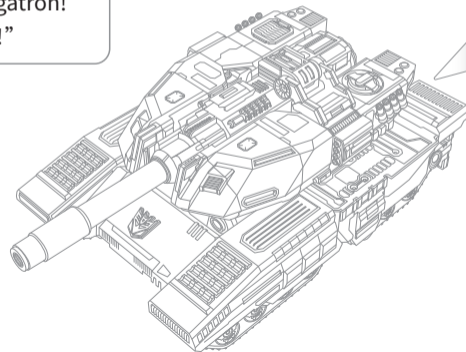

What's wrong! 🗣️

4. Voice Commands / 语音指令词 / 語音指令詞 / 音声コマンド / 음성 명령 / Commandes vocales / Sprachbefehle / Comandos de Voz / Comandi vocali / Spraakopdrachten



Hey, Megatron & Hi, Megatron & All Hail Megatron

Convert | Move Forward | Move Backward | Turn Left | Turn Right | Turn Around | Move Left | Move Right

Introduce Yourself	Open Fire	Unicron	Fusion Canon	Happy Birthday	Soundwave
What Can You Do	Attack	Galvatron	Energon Sword	Happy Holiday	Laserbeak
Hello	Defense	Optimus Prime	Conquer	Energon	Fate
Show	Retreat	Autobots	Great-villain	Cybertron	Earth
Next	Victory	Decepticons	Conspiracy	Starscream	...

Start Voice Programming | Execute | Start Easy Programming | Play | Cancel

Turn It Up | Max Volume | Turn It Down | Mute | Shutdown

EN/CHT/JP/KR/FR/DE/ES/IT/NL



嘿, 威震天 & 嗨, 威震天 & 威震天万岁

变形 | 前进 | 后退 | 左转 | 右转 | 转身 | 左移 | 右移

自我介绍	开火	擎天柱	枭雄	宿命	节日快乐
你会什么	攻击	汽车人	阴谋	地球	红蜘蛛
你好	防御	集结, 霸天虎	征服	能量块	声波
表演一下	撤退	宇宙大帝	融合炮	塞伯坦	激光鸟
下一个	胜利	惊破天	星辰剑	生日快乐	...

开始语音编程 | 执行 | 开始简易编程 | 播放 | 取消

增大音量 | 声音最大 | 减小音量 | 静音 | 关机

CHS

5. Touch Interaction / 触摸交互 / 觸摸交互 / 터치인터랙션 / 터치 인터랙티브 / Interaction tactile / Touchfunktion / Interacción táctil / Interazione tattile / Raak Interactie

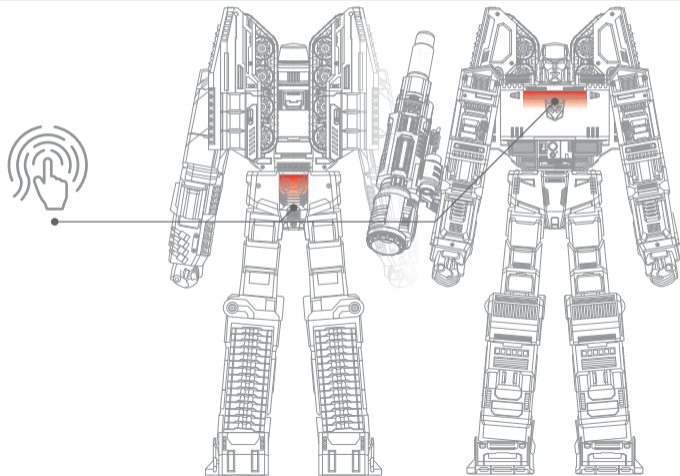

6. Easy Programming / 简易编程 / 簡易編程 / 簡単プログラミング / 쉬운 프로그래밍 / Programmation facile / Einfache Programmierung / Programación Fácil / Programmazione facile / Eenvoudig Programmeren



(Global)



(中国大陆地区专用)

7. Accessories Assembly / 配件组装 / 配件組裝 / アクセサリーの取り付け / 액세서리 조립 / Montage des accessoires / Zubehör Montage / Montaje de Accesorios / Montaggio accessori / Assemblage van Accessoires

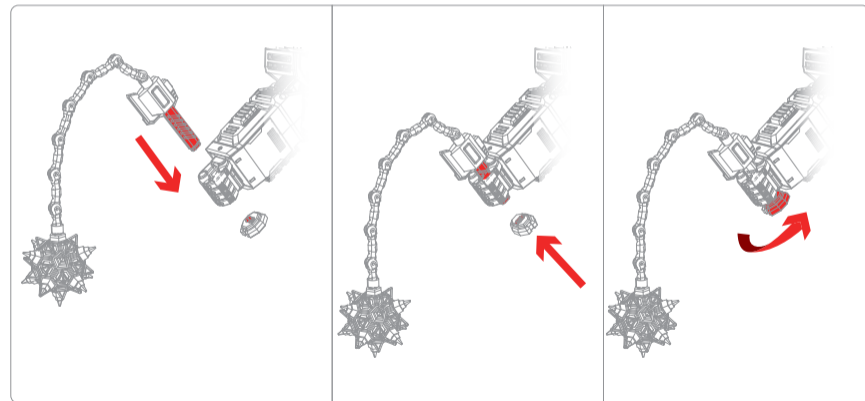
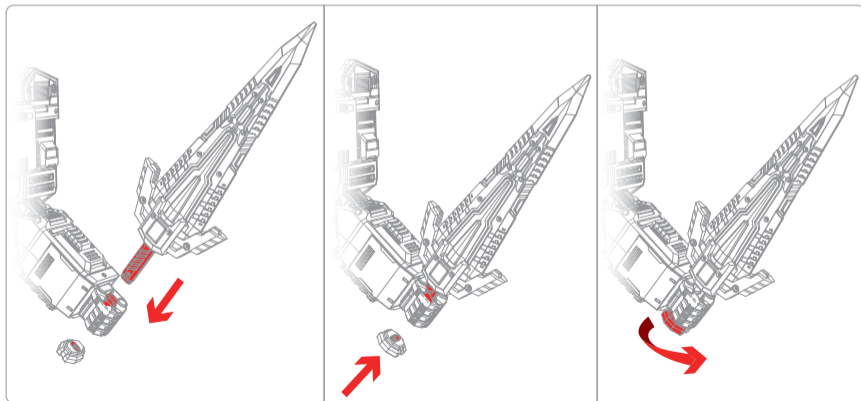

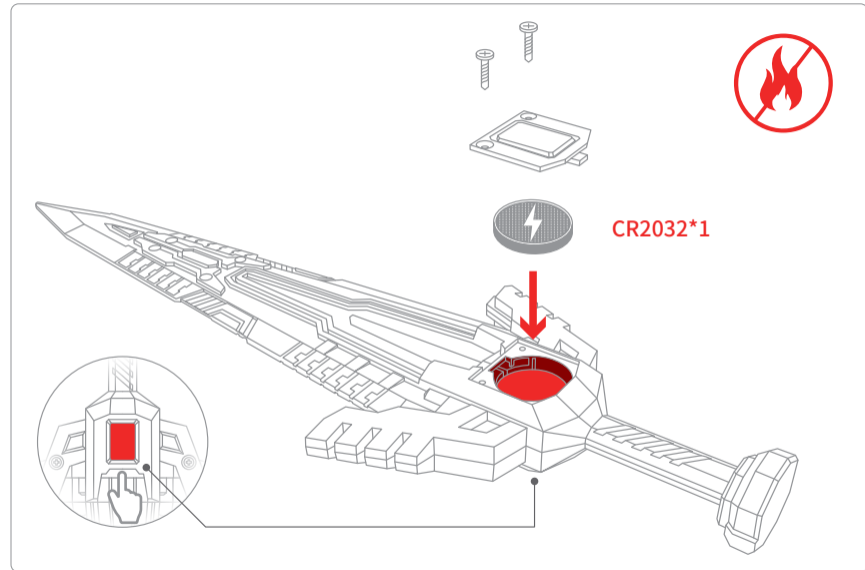
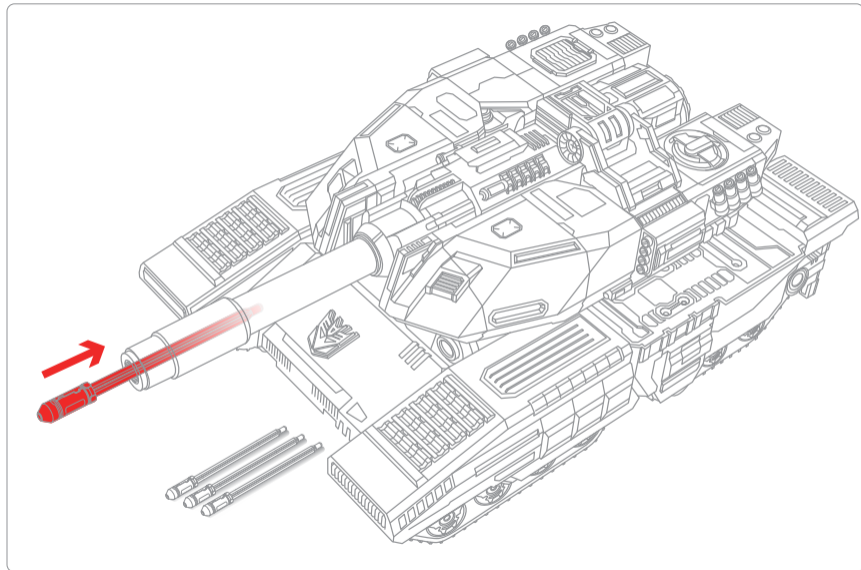

8. Download the App / 下载App / 下载应用程序 / アプリダウンロード / 앱 다운로드 / Télécharger l'application / Herunterladen der App / Descargar la Aplicación / Scarica l'app / Download App



(Global)

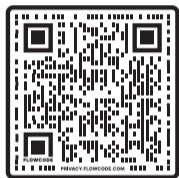

(中国大陆地区专用)

“Robosen Megatron G1”



“乐森威震天G1”



9. Charging / 充电 / 充電 / 充電 / 충전 중 / En cours de chargement / Ladevorgang / Cargando / Ricarica / Opladen

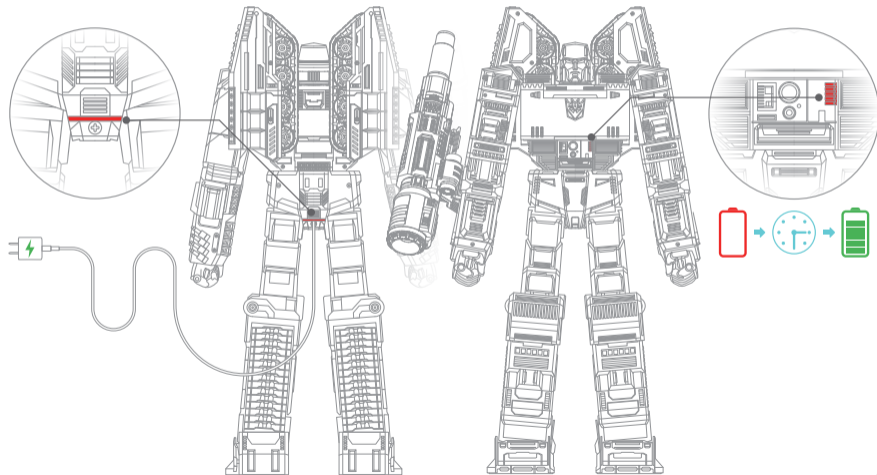

10. Read the User Manual / 阅读用户手册 / 閱讀用戶手冊 / ユーザーマニュアルを読む / 사용 설명서 읽기 / Lire le Manuel d'utilisation / Lesen Sie die Bedienungsanleitung / Lea el Manual del Usuario / Leggi il manuale d'uso / Lezen Gebruikershandleiding

www.robosen.com/support

www.robosen.cn/support

11. Contact Us / 联系我们 / 聯繫方式 / お問い合わせ先 / 문의하기 / Contactez-nous / Kontakt / Contacte con nosotros / Contattaci / Neem Contact Met Ons Op



www.robosen.com / www.robosen.cn



[robosenofficial](https://twitter.com/robosenofficial)



[Robosen_Official](https://www.facebook.com/Robosen_Official)



[robosenofficial](https://www.instagram.com/robosenofficial)



[RobosenOfficial](https://www.youtube.com/RobosenOfficial)



support@robosen.com



[robosen乐森机器人](https://www.robosen.com/robot)

Make Life More Fun